

Plate Cartridge Compact Flexible Automatic Feed System

Carter L. Boad and Kevin Brandenstein
Electroimpact Inc.

ABSTRACT

The newest generation of automated fastening machines require a feed system that is smaller, more flexible, and faster than any currently available. The feed system must be compact enough to fit on a robot base, yet have a capacity large enough to support unmanned production for hours. A large variety of fasteners must be supported and the entire system must be reloaded or reconfigured in minutes to match the next work piece being assembled by the machine. When requested by the part program, the correct fastener must be released directly and immediately into the feed tube to minimize cycle time. This paper describes a new “plate cartridge” feed system developed to meet these needs.

CITATION: Boad, C. and Brandenstein, K., "Plate Cartridge Compact Flexible Automatic Feed System," *SAE Int. J. Aerosp.* 9(1):2016, doi:10.4271/2016-01-2080.

INTRODUCTION

In late 2013, Electroimpact was working on a proposal for Boeing for automated machinery to replace their aging ASAT3 737 spar assembly machines. The new SAL (Spar Assembly Line) machines were required to be approximately half the size of the ones they were replacing in order to facilitate two of them working on a single spar at the same time. One of the largest obstacles facing the miniaturization of the new machines was reducing the size of the fastener feed system.

The old machines used a combination of hoppers and hangers for feeding bolts, and vertical cartridges for feeding slug rivets, nuts, and collars. The rack of 42 hoppers alone was 3m long in the X-axis, longer than the entire new machine. In addition, when feeding nuts and collars, only one cartridge could be installed at a time. An operator was required to swap cartridges as part of the tool change carried out each time a different fastener type/diameter was required. Boeing mandated that the new machines carry out tool changes without operator assistance. That meant that over 67 different fastener type/diameter/grip combinations along with four collar and four nut diameters would need to be carried on the machine at all times.

In addition, even though two machines would now be working on the spar at the same time, each machine was required to be faster than the machine it replaced. With all other aspects of the machine benefiting from 20 years of development toward faster cycle times, the new fastener feed system would have to significantly quicker than the system it replaces.

CONCEPT

Work began on a remote feed system using conventional hoppers and vibratory bowls that would send fasteners to the machine when called on. This remote feed system would sit just outside the manufacturing cell and send fasteners to the machine through the x-axis cable track. Unfortunately, it became apparent early on that a system like this could not supply the fasteners quickly enough due to the transit time over the long fastener feed tubes required to reach the machine.

Next, an intermediate feed system called a buffer was considered which would be located on each machine. The buffer would store a small number of each fastener within reasonable distance to the tool point and would then be reloaded from the centralized feed system. This concept would meet the required cycle time spec but it essentially meant building two complete feed systems for each machine. This represented unfavorable cost, complexity, and maintenance downtime risk.

The final attempt at this concept was a “centralized feed system” where one remote feed system would supply fasteners to multiple machines, each carrying a buffer feed system. Although this concept showed a reduction in cost and part count, it increased the complexity and also increased the risk since more than one machine would be affected by a failure on the centralized feed system.

It has been said that “necessity is the mother of invention”.

At this point, it became obvious that to succeed with the proposal, a break from convention was required. Development began on a new feed system that was small enough to fit on the machine, fast enough to support improved cycle times, and with a capacity large enough to feed the full range of required fasteners without operator intervention.

The new invention is called the Plate Cartridge Flexible Automatic Feed System.

DESCRIPTION

The Plate Cartridge feed system is comprised of three main parts. The Plate Cartridges which store the fasteners, the On-Line system which removes the fasteners from the cartridges and sends them to the tool point, and the Off-Line system which re-loads the cartridges once they are empty.

Plate Cartridges

The plate cartridge is an assembly consisting of closely spaced vertical columns each with an integrated, passive, two-finger escapement mechanism at the base. Depending on the size of the fastener, there are eight to sixteen columns in each plate. Bolts and other headed fasteners use columns with a round cross section, nuts and collars use columns with a rectangular cross section. Each plate cartridge also has a Balluff RFID chip to carry details such as type and quantity of fastener in each column. The plates weigh approximately 6-10 kg (13-22 lbs) each when full and are sized to carry the maximum amount of fasteners possible without exceeding the customer's manual handling ergonomic limits. The cartridges also have a spring loaded gate at the top to ensure that fasteners do not fall out during transport from the off-line filling station to the online system.

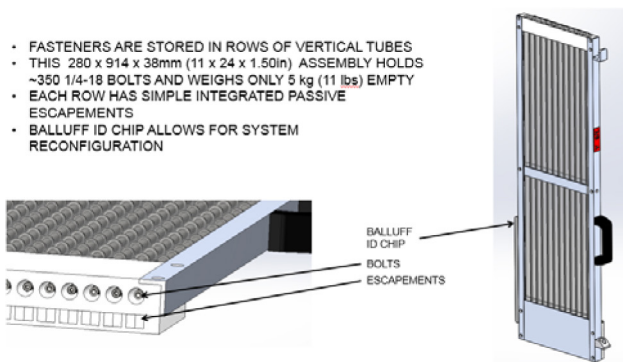

Figure 1. Plate Cartridge for Bolts

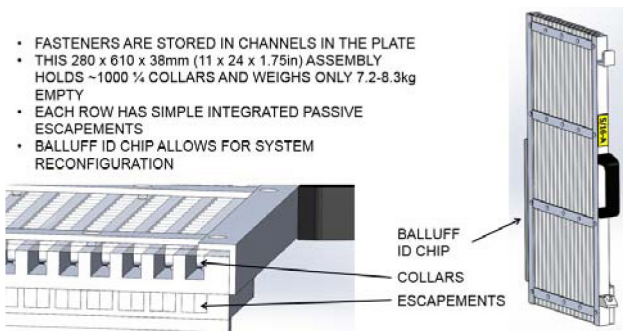

Figure 2. Plate Cartridge for Nuts and Collars

A typical cartridge has lightweight aluminum framework joining the base plate with the top plate. There is an escapement plate fastened to the base plate. The escapement plate houses pairs of spring loaded

escapement fingers and actuators, one pair for each column. The top plate contains a spring loaded gate. Suspended between the base plate and top plate are a series of parallel HDPE tubes in which the fasteners are stored head-to-tail. The Balluff chip is mounted to the back of the cartridge and a handle is mounted to the front.

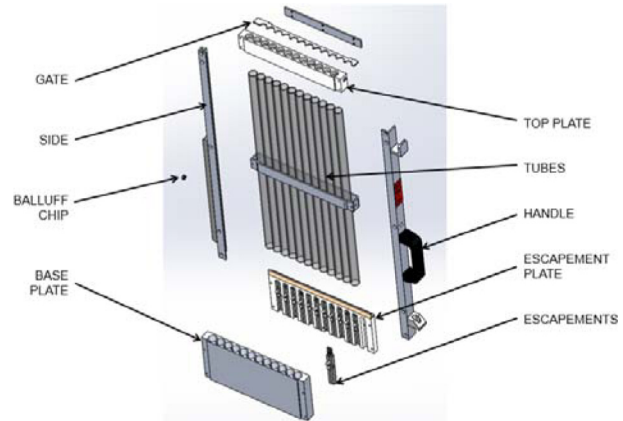

Figure 3. Plate Cartridge Exploded View

In a collar/nut cartridge; the baseplate, top plate, and parallel channels (taking the place of the tubes) are machined from a single piece of Delrin plate, with a polycarbonate cover added to close out the feed paths.

The escapement finger and actuator pairs are shown in the figure below. When the machine requests a fastener from a column, the left actuator is raised against its spring, withdrawing the lower escapement finger from the column and letting the fastener drop from the cartridge. This actuator is then allowed to return to its at-rest position. To re-index the column, the right actuator is raised against its spring, withdrawing the upper escapement finger allowing the column of fasteners to drop down to the lower escapement. The next fastener is now ready to be released.

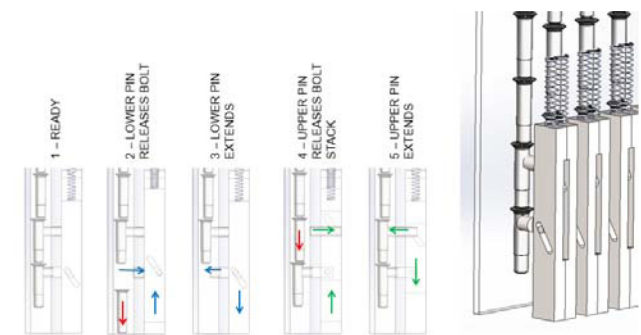

Figure 4. Escapement Process

On-Line System

The first iteration of the online system is designed to feed fasteners, nuts, and collars to the machine's tool point for automated installation. Due to the overall machine constraints, the resultant system is very compact, lightweight, and modular. It consists of a

welded, aluminum frame, two separate servo driven X-Y tables, and two separate blast valve selector heads. One X-Y table and blast valve selector head unit feeds bolts and the other feeds nuts and collars. It is designed to hold twelve bolt cartridges and six nut or collar cartridges. The whole system measures about 1400mm (55in) wide x 740mm (29in) deep x 1200mm (47in) in height. Height is measured from the bottom of the welded frame to the top of a loaded fastener plate cartridge. Due to the ergonomic issues with loading and un-loading plate cartridges, the whole system is raised off the floor to put the plate cartridges at a comfortable hand/shoulder height.



Figure 5. First Production Plate Cartridge System

The system's base frame integrates a locking mechanism to index the plate cartridges and secure them in place during operation. Sensors alert the CNC that the plate cartridges are properly locked in so production can begin.

The cartridge plates are loaded along the system's X-axis. The different slots in a given plate cartridge are along the system's Y-axis. This creates an X-Y grid that the blast valve selector head indexes under. The X-Y table drives the selector head to the programmed plate and slot where the correct fastener can be released.

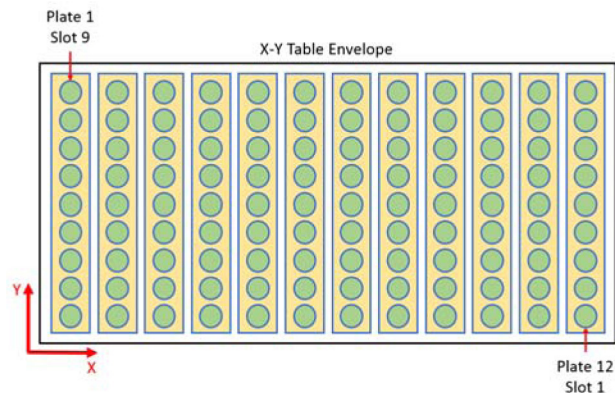

Figure 6. X-Y Table Configuration

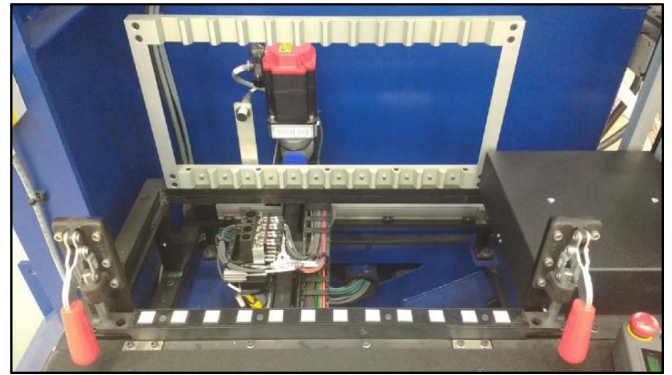

Figure 7. X-Y Table

A RFID system is implemented into the X-Y table as well. A read head is attached to the system's X-axis and reads a chip embedded in the back of each plate cartridge. Once the CNC confirms that the locking mechanism is in place, a scan routine is initiated to determine which plate in each position on the rack.



Figure 8. RFID Readhead Reading Chip in Plate Cartridge

The blast valve selector head releases a fastener from the specified plate cartridge slot and delivers it to the machine tool point at high speeds using compressed air and flexible feed tubes. There is a separate station for each size fastener that the system is designed to feed.

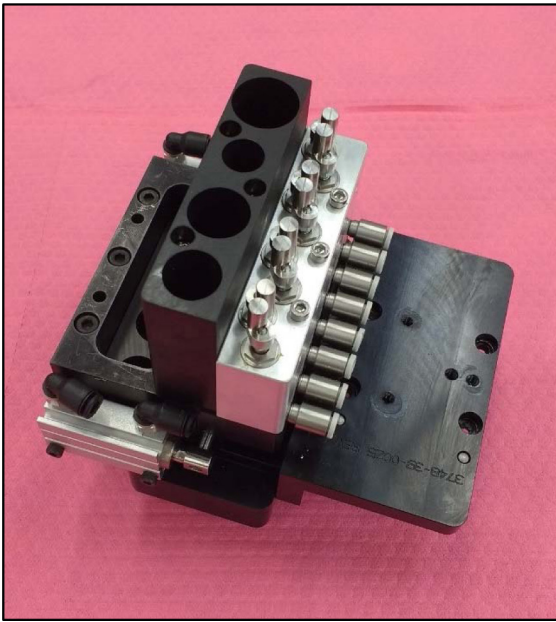

Figure 9. Fastener Blast Valve Selector; 4 Stations

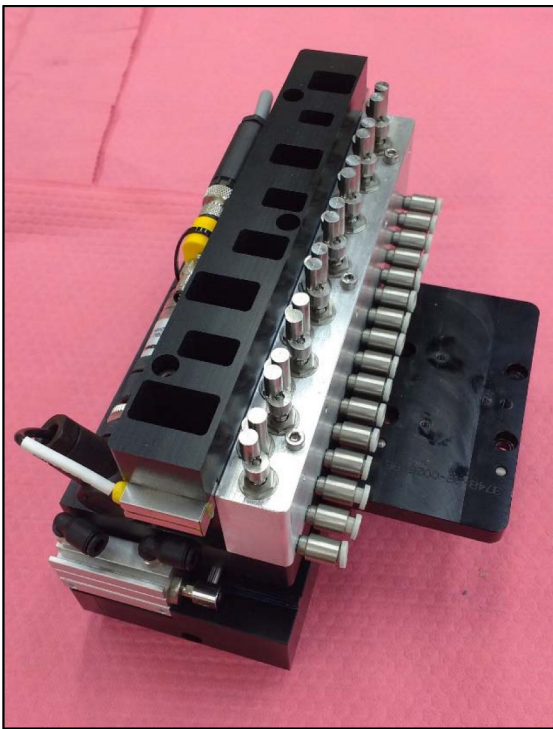

Figure 10. Nut and Collar Blast Valve Selector; 8 Stations

The main components of the blast valve selector head are the escapement cylinders and the trap door. The escapement cylinders are a custom manifold of air cylinders that raise the passive escapement actuators in a cartridge to release a fastener. The trap door allows the fastener to drop through the selector head into the feed tubes and then closes that path to redirect the blast air through the feed tube, blowing the fastener to the machine head.

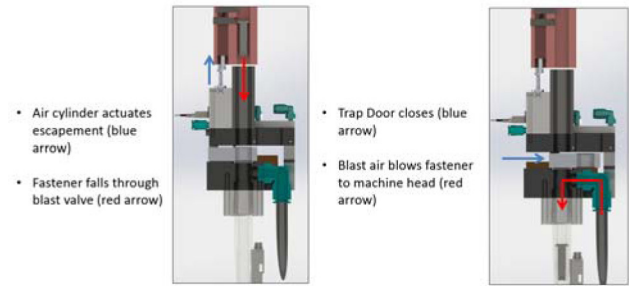

Figure 10. Blast Valve Selector Head Function

Off-Line System

The cartridges can be loaded with traditional off-line filling equipment such as vibratory bowls or with hoppers dedicated to each fastener type.

The cartridges are placed in an off-line loading station where the Balluff ID chip is read to determine which fasteners are needed to fill each column. Work instructions are generated and passed to the operator so they are able to fill the bowl with the correct fasteners to load the cartridge.

DEVELOPMENT

Once the plate cartridge escapement concept was conceived, a simple two column prototype was created using clear polycarbonate for the base to allow visibility of the process.



Figure 11. Two Column Prototype

This early prototype demonstrated that the concept was sound. The next step was to build one of each cartridge type using appropriate materials in order to evaluate the full range of fastener/cartridge combinations and also to begin cycle testing the escapements to make

sure they wouldn't wear or break during the intended lifetime of a minimum of 10 years. Cycle testing required integration with the prototype online system which is described below. Once the escapement mechanisms were cycled over one hundred thousand times (representing 1.6 million cycles in a single cartridge), production of the first batch of cartridges was approved.

Development of the online system started with the blast valve selector head. A compact feed system was required, so developing a small selector head was a first priority. One of the main challenges in the design was packaging the required number of air cylinders for the stations on the selector head. After looking at many off the shelf cylinders, a custom air cylinder manifold was designed. The cylinder bore of all the air cylinders is machined from a single block of aluminum and the individual, non-rotating piston rods are installed in the single block. To minimize the required pneumatic lines running to the selector head, the air cylinders are spring-return. This resulted in the eight required air cylinders for the four stations of the fastener blast valve selector head being packaged extremely close together. This design was then extended to sixteen air cylinders for the eight stations on the nut and collar blast valve selector head.



Figure 12. Fastener Escapement Cylinder Assembly; 8 Air Cylinders.

PERFORMANCE

A new feed system that was compact, fast, and flexible enough to handle the large variety of fasteners and support the required rate of production for the overall machine drove the development of the plate cartridge system.

Escaping the fasteners from the bottom of the cartridge plates means they only have to fall a short distance before being picked up by the sensors on the feed tubes. At this point, the blast air is triggered and accelerates the fastener to an average speed of 22-27 meters per second (50-60 mph) on its way to the machine head. Average time between the CNC calling for a fastener and the fastener being picked up by the feed tube sensor is around 300 ms. Drive components on

the X-Y table were chosen to optimize speed and acceleration so moving between different cartridge plates or slots has a minimal impact on cycle time.

FLEXIBILITY

This system can easily be configured for different fasteners or capacities depending on the customer's needs. This is apparent by comparing the fastener with the nut and collar blast valve selector head. Both attach to their respective X-Y tables identically and function identically. However, the fastener selector head has four stations and feeds bolts, while the nut and collar selector head has eight stations and feeds nuts and collars. Each selector head can be configured to feed whatever the customer needs with minimal engineering time.

In addition, by changing the travel of the X-Y table, the capacity of the system can be increased or decreased accordingly.

Another comparison is summarized in Figure 14 between the system described in this paper (System 1) and another system built later for another project (System 2). System 2 was able to be built quickly and with little additional engineering time since the majority of design could be carried over from System 1. A third system is in development which feeds sleeved bolts and Centrix single sided slave bolts for a composite with manufacturing cell.



Figure 13. System 2

| | System 1 | System 2 |
|--|--|--|
| Feeds | Fasteners, Nuts, and Collars | Fasteners |
| Bolt Types | 3/16", 1/4", 5/16", 3/8" Protruding Head Bolts | 3/16", 1/4", 5/16", 3/8" Countersunk Bolts |
| Nuts and Collars | 3/16", 1/4", 5/16", 3/8" Nuts and Collars | NA |
| Fastener Cartridge Capacity | 12 | 12 |
| Nut and Collar Cartridge Capacity | 6 | NA |
| CNC/Motor Manufacturer | Fanuc | Siemens |
| I/O Communication Protocol | Ethernet/IP | Profinet |
| Dimensions (W x D x H) | 55" x 29" x 47" | 38" x 29" x 47" |

Figure 14. Table Comparison of Two Plate Cartridge Feed Systems

SUMMARY

A new machine configuration required by a customer to meet their production and automation goals necessitated a fastener feed system that did not previously exist. The Plate Cartridge Flexible Automated Feed System was created to answer this need by carrying a large enough volume and variety of fasteners in a small enough space, and

by delivering fasteners to the tool point in record time. Meeting these goals played a necessary part in the success of the new SAL production cell. In addition, the new feed system has proven flexible enough to already be adapted to two other completely different manufacturing systems to date.

REFERENCES

1. Rink, P., Givler, G., Stancik, B., and Nary, W., "New Generation Automated Fastener Feed Systems," SAE Technical Paper 952169, 1995, doi:10.4271/952169.

CONTACT INFORMATION

Carter Boad is a Lead Mechanical Engineer and Project Manager and Kevin Brandenstein is a Project Engineer at Electroimpact Inc.

Carter Boad
Electroimpact, Inc.
carterb@electroimpact.com

Kevin Brandenstein
Electroimpact, Inc.
kevinb@electroimpact.com

DEFINITIONS/ABBREVIATIONS

ASAT: - Automatic Spar Assembly Tool.

SAL: - Spar Assembly Line.

RFID: - Radio Frequency Identification.

CNC: - Computer Numerical Control.

Online: - Directly attached to an assembly or riveting machine.

Offline: - Located away from the assembly machine, in some cases in a different building.